

Enhancement Mode N-Channel Power MOSFET

Features

- ◆ Ultra-fast and robust body diode
- ◆ Low $R_{DS(on)}$ & FOM
- ◆ Excellent low switching loss
- ◆ Excellent stability and uniformity
- ◆ Easy to drive

Applications



- ◆ Lighting
- ◆ Server power supply
- ◆ Telecom
- ◆ Solar inverter

■ General Description

OSG65R140xSZF use advanced GreenMOS™ technology to provide low $R_{DS(ON)}$, low gate charge, fast switching and excellent avalanche characteristics. This device offers extremely fast and robust body diode, and is suitable for telecom and power supplies.

◆ $V_{DS, min@Tjmax}$	700 V
◆ $I_D, pulse$	75 A
◆ $R_{DS(ON), max @ V_{GS}=10 V}$	140 mΩ
◆ Q_g	55.2 nC

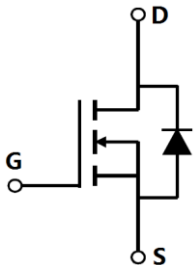
■ Schematic and Package Information

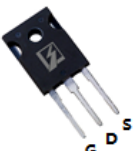
Schematic Diagram	Pin Assignment-Top View		
	 <p>TO220F OSG65R140FSZF</p>	 <p>TO263 OSG65R140KSZF</p>	 <p>TO247 OSG65R140HSZF</p>

■ Absolute Maximum Ratings at $T_j=25^{\circ}C$ unless otherwise noted

Parameter	Symbol	Value	Unit
Drain source voltage	V_{DS}	650	V
Gate source voltage	V_{GS}	±30	V
Continuous drain current ¹⁾ $T_C=25^{\circ}C$	I_D	25	A
Continuous drain current ¹⁾ $T_C=100^{\circ}C$		16	
Pulsed drain current ²⁾ $T_C=25^{\circ}C$	$I_{D, pulse}$	75	A
Power dissipation ³⁾ for TO263, TO247, $T_C=25^{\circ}C$	P_D	219	W
Power dissipation ³⁾ for TO220F, $T_C=25^{\circ}C$		34	
Single pulsed avalanche energy ⁵⁾	E_{AS}	1000	mJ
MOSFET dV/dt ruggedness, $V_{DS}=0...480 V$	dV/dt	50	V/ns
Reverse diode dV/dt, $V_{DS}=0...480 V, I_{SD} \leq I_D$	dV/dt	50	V/ns
Operation and storage temperature	T_{stg}, T_j	-55 to 150	°C

■ Thermal Characteristics

Parameter	Symbol	Value		Unit
		TO247/TO263	TO220F	
Thermal resistance, junction-case	$R_{\theta JC}$	0.57	3.7	$^{\circ}\text{C}/\text{W}$
Thermal resistance, junction-ambient ⁴⁾	$R_{\theta JA}$	62	62.5	$^{\circ}\text{C}/\text{W}$

■ Electrical Characteristics at $T_j=25^{\circ}\text{C}$ unless otherwise specified

Parameter	Symbol	Min.	Typ.	Max.	Unit	Test condition
Drain-source breakdown voltage	BV_{DSS}	650			V	$V_{GS}=0\text{ V}, I_D=1\text{ mA}$
		700	750			$V_{GS}=0\text{ V}, I_D=1\text{ mA}, T_j=150^{\circ}\text{C}$
Gate threshold voltage	$V_{GS(th)}$	3.0		4.5	V	$V_{DS}=V_{GS}, I_D=1\text{ mA}$
Drain-source on-state resistance	$R_{DS(on)}$		0.12	0.14	Ω	$V_{GS}=10\text{ V}, I_D=12.5\text{ A}$
			0.30			$V_{GS}=10\text{ V}, I_D=12.5\text{ A}, T_j=150^{\circ}\text{C}$
Gate-source leakage current	I_{GSS}			100	nA	$V_{GS}=30\text{ V}$
				-100		$V_{GS}=-30\text{ V}$
Drain-source leakage current	I_{DSS}			10	μA	$V_{DS}=650\text{ V}, V_{GS}=0\text{ V}$

■ Dynamic Characteristics

Parameter	Symbol	Min.	Typ.	Max.	Unit	Test condition
Input capacitance	C_{iss}		2855.4		pF	$V_{GS}=0\text{ V}, V_{DS}=50\text{ V}, f=100\text{ kHz}$
Output capacitance	C_{oss}		151.1		pF	
Reverse transfer capacitance	C_{rss}		7.7		pF	
Turn-on delay time	$t_{d(on)}$		56.3		ns	$V_{GS}=10\text{ V}, V_{DS}=400\text{ V}, R_G=2\ \Omega, I_D=16\text{ A}$
Rise time	t_r		68.8		ns	
Turn-off delay time	$t_{d(off)}$		108.5		ns	
Fall time	t_f		31.6		ns	

■ Gate Charge Characteristics

Parameter	Symbol	Min.	Typ.	Max.	Unit	Test condition
Total gate charge	Q_g		55.2		nC	$I_D=16\text{ A}$, $V_{DS}=400\text{ V}$, $V_{GS}=10\text{ V}$
Gate-source charge	Q_{gs}		13.7		nC	
Gate-drain charge	Q_{gd}		24.0		nC	
Gate plateau voltage	V_{plateau}		6.8		V	

■ Body Diode Characteristics

Parameter	Symbol	Min.	Typ.	Max.	Unit	Test condition
Diode forward current	I_S			25	A	$V_{GS} < V_{th}$
Pulsed source current	I_{SP}			75		
Diode forward voltage	V_{SD}			1.3	V	$I_S=25\text{ A}$, $V_{GS}=0\text{ V}$
Reverse recovery time	t_{rr}		126.0		ns	$V_R=400\text{ V}$, $I_S=16\text{ A}$, $di/dt=100\text{ A}/\mu\text{s}$
Reverse recovery charge	Q_{rr}		0.7		μC	
Peak reverse recovery current	I_{rrm}		10.6		A	

■ Note

- 1) Calculated continuous current based on maximum allowable junction temperature.
- 2) Repetitive rating; pulse width limited by max. junction temperature.
- 3) P_d is based on max. junction temperature, using junction-case thermal resistance.
- 4) The value of $R_{\theta JA}$ is measured with the device mounted on 1 in 2 FR-4 board with 2oz. Copper, in a still air environment with $T_a=25\text{ }^\circ\text{C}$.
- 5) $V_{DD}=100\text{ V}$, $R_G=50\text{ }\Omega$, $L=60\text{ mH}$, starting $T_j=25\text{ }^\circ\text{C}$.

■ **Electrical Characteristics Diagrams**

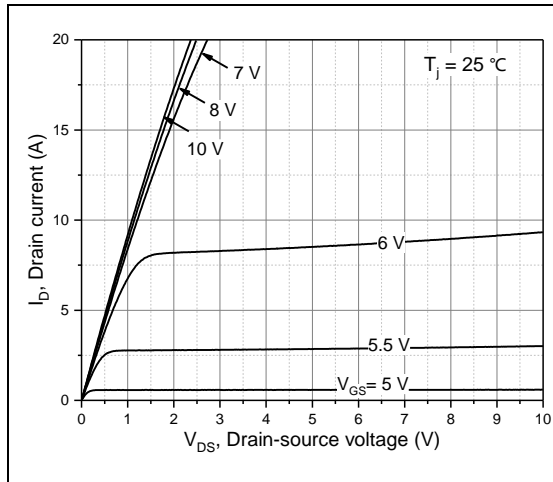

Figure 1, Typ. output characteristics

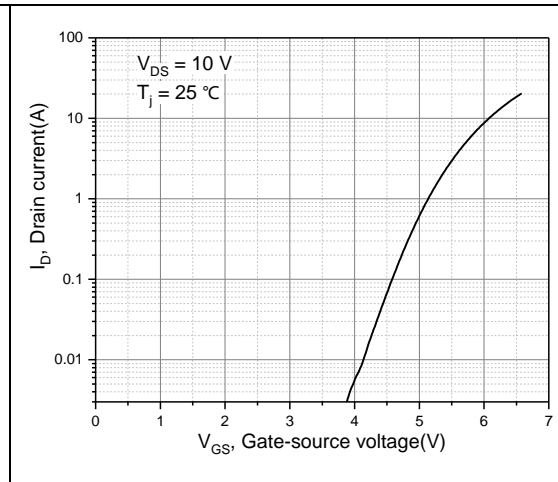

Figure 2, Typ. transfer characteristics

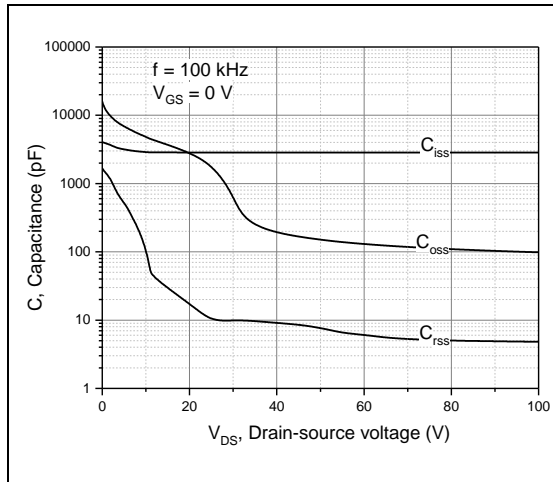

Figure 3, Typ. capacitances

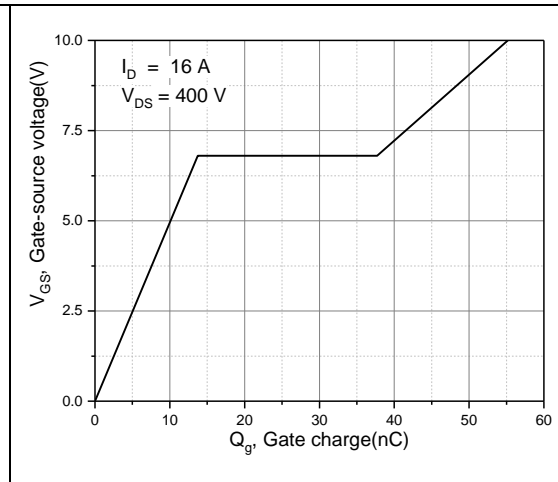

Figure 4, Typ. gate charge

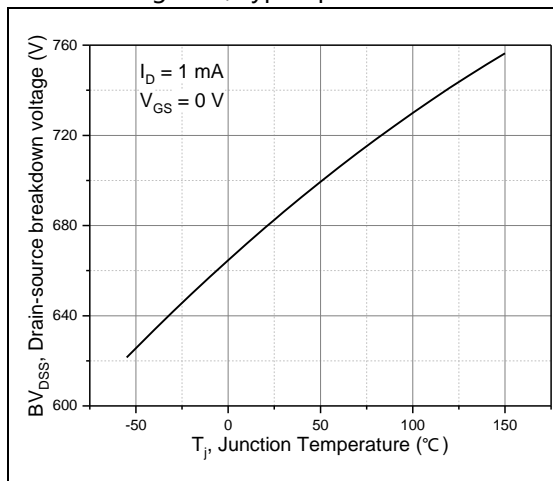

Figure 5, Drain-source breakdown voltage

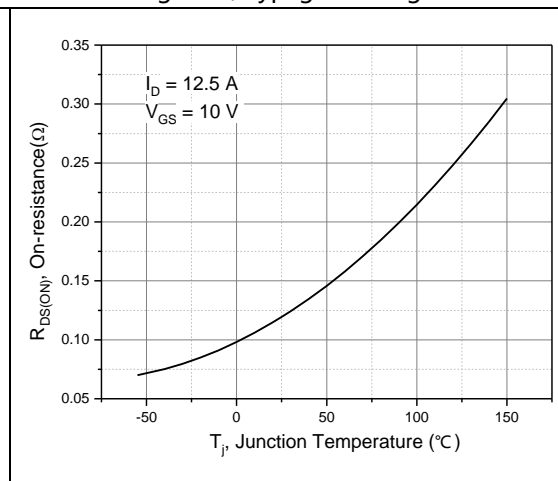

Figure 6, Drain-source on-state resistance

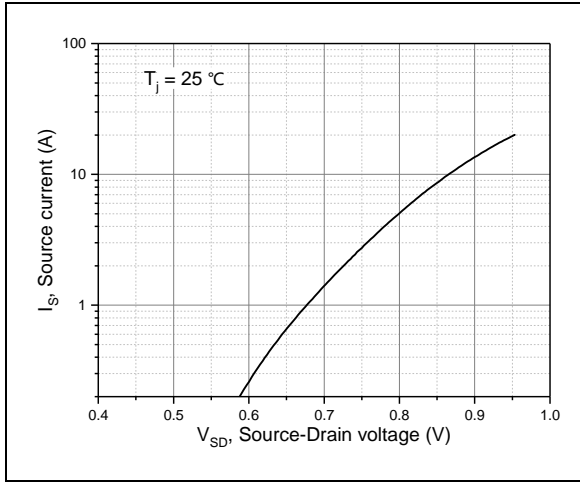

Figure 7, Forward characteristic of body diode

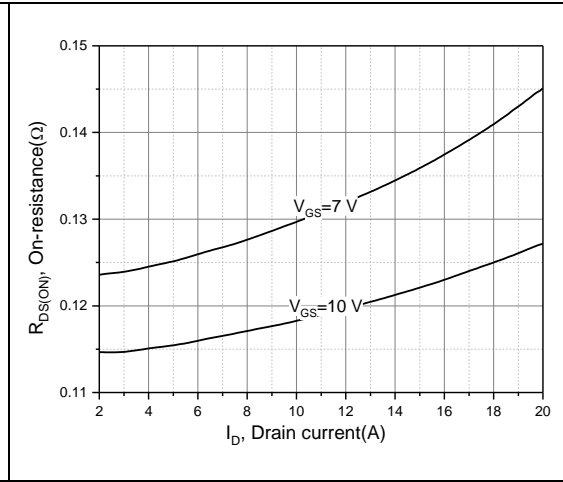

Figure 8, Drain-source on-state resistance

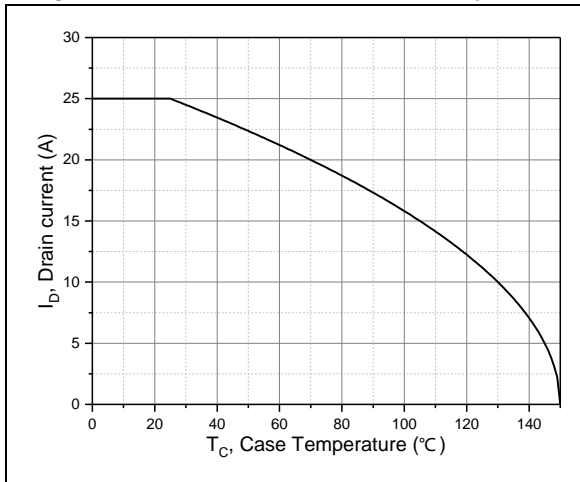

Figure 9, Drain current

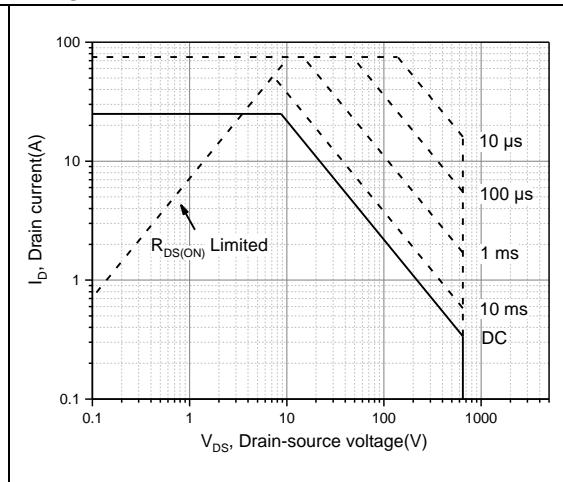

Figure 10, Safe operation area for TO263/TO247 $T_c=25\text{ °C}$

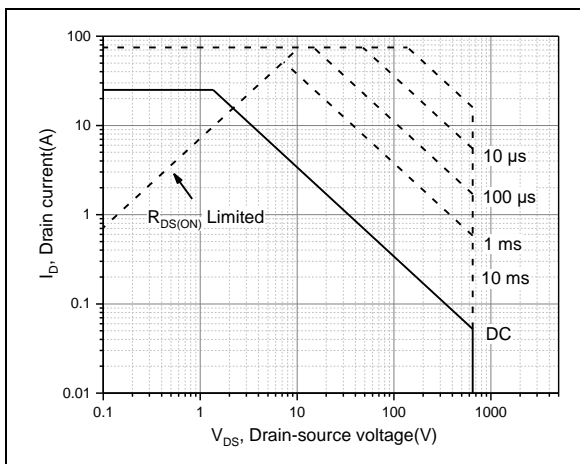

Figure 11, Safe operation area for TO220F $T_c=25\text{ °C}$

■ Test circuits and waveforms

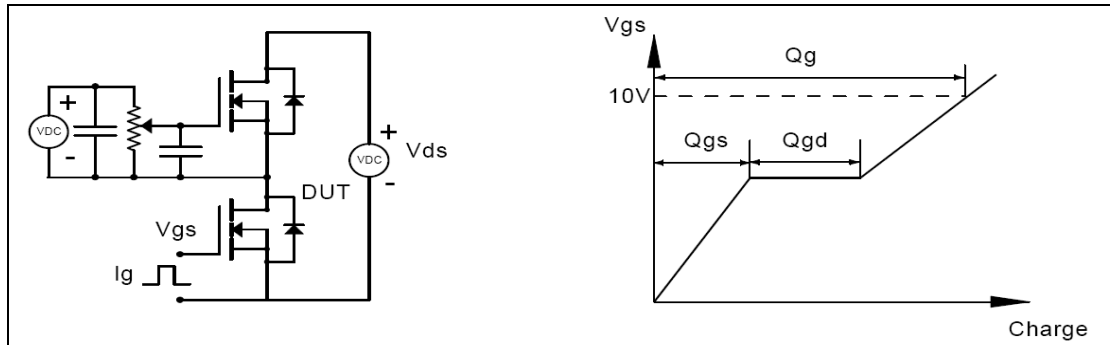

Figure 1, Gate charge test circuit & waveform

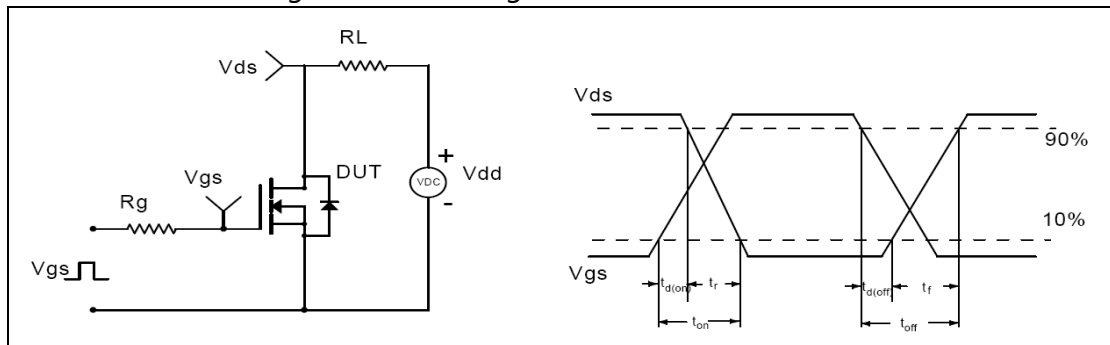

Figure 2, Switching time test circuit & waveforms

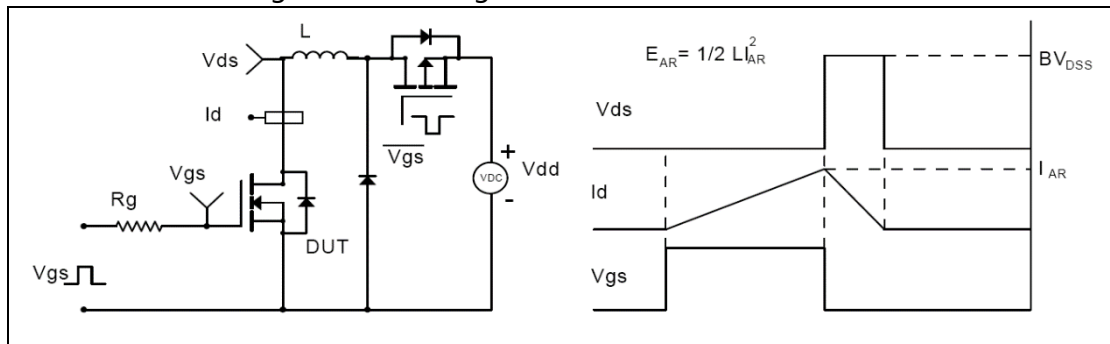

Figure 3, Unclamped inductive switching (UIS) test circuit & waveforms

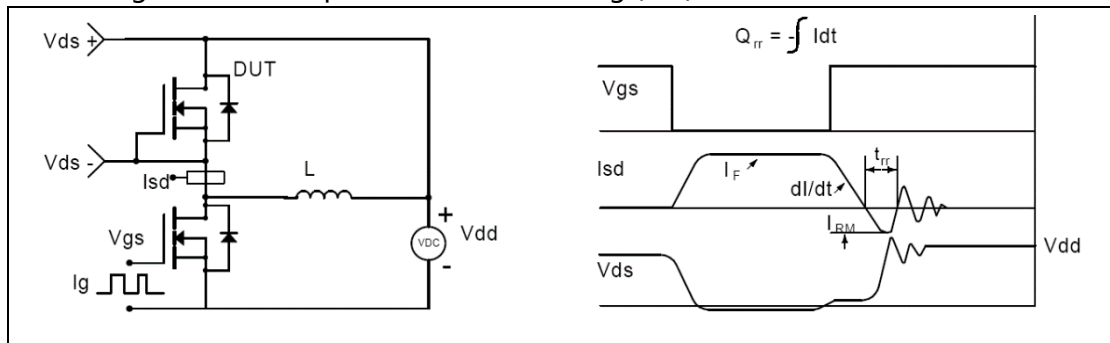
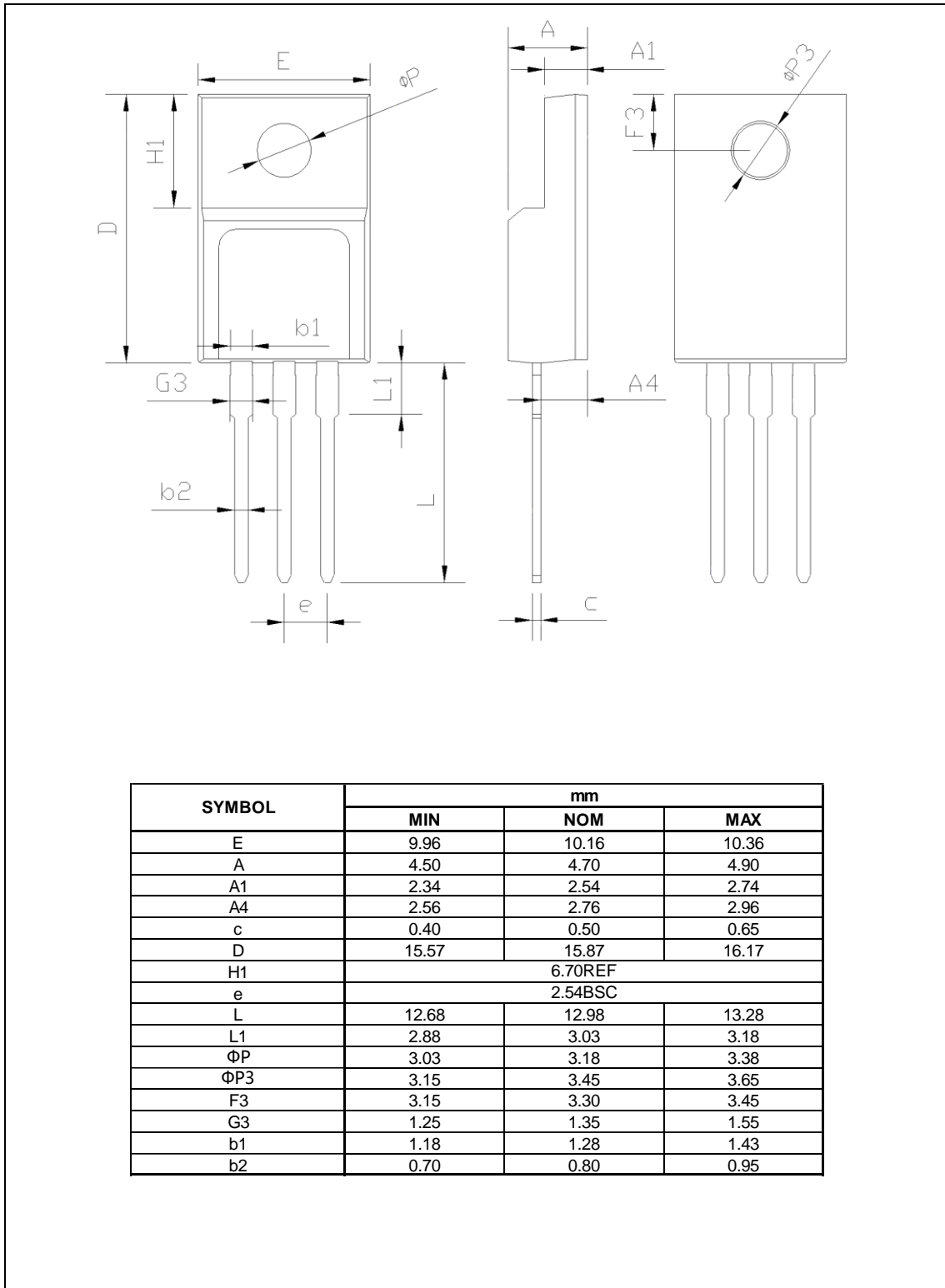

Figure 4, Diode reverse recovery test circuit & waveforms

■ Package Information

Figure1, TO220F package outline dimension



■ Package Information

Figure2, TO263 package outline dimension

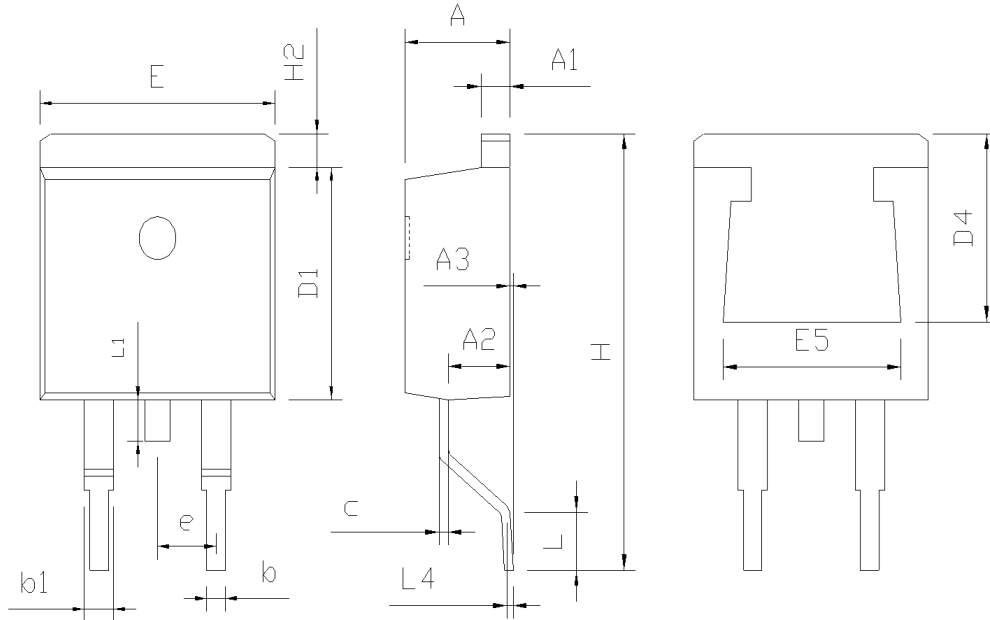

SYMBOL	mm		
	MIN	NOM	MAX
A	4.37	4.57	4.77
A1	1.22	1.27	1.42
A2	2.49	2.69	2.89
A3	0.00	0.13	0.25
b	0.70	0.81	0.96
b1	1.17	1.27	1.47
c	0.30	0.38	0.53
D1	8.50	8.70	8.90
D4	6.60	-	-
E	9.86	10.16	10.36
E5	7.06	-	-
e	2.54 BSC		
H	14.70	15.10	15.50
H2	1.07	1.27	1.47
L	2.00	2.30	2.60
L1	1.40	1.55	1.70
L4	0.25 BSC		

■ Package Information

Figure3, TO247 package outline dimension

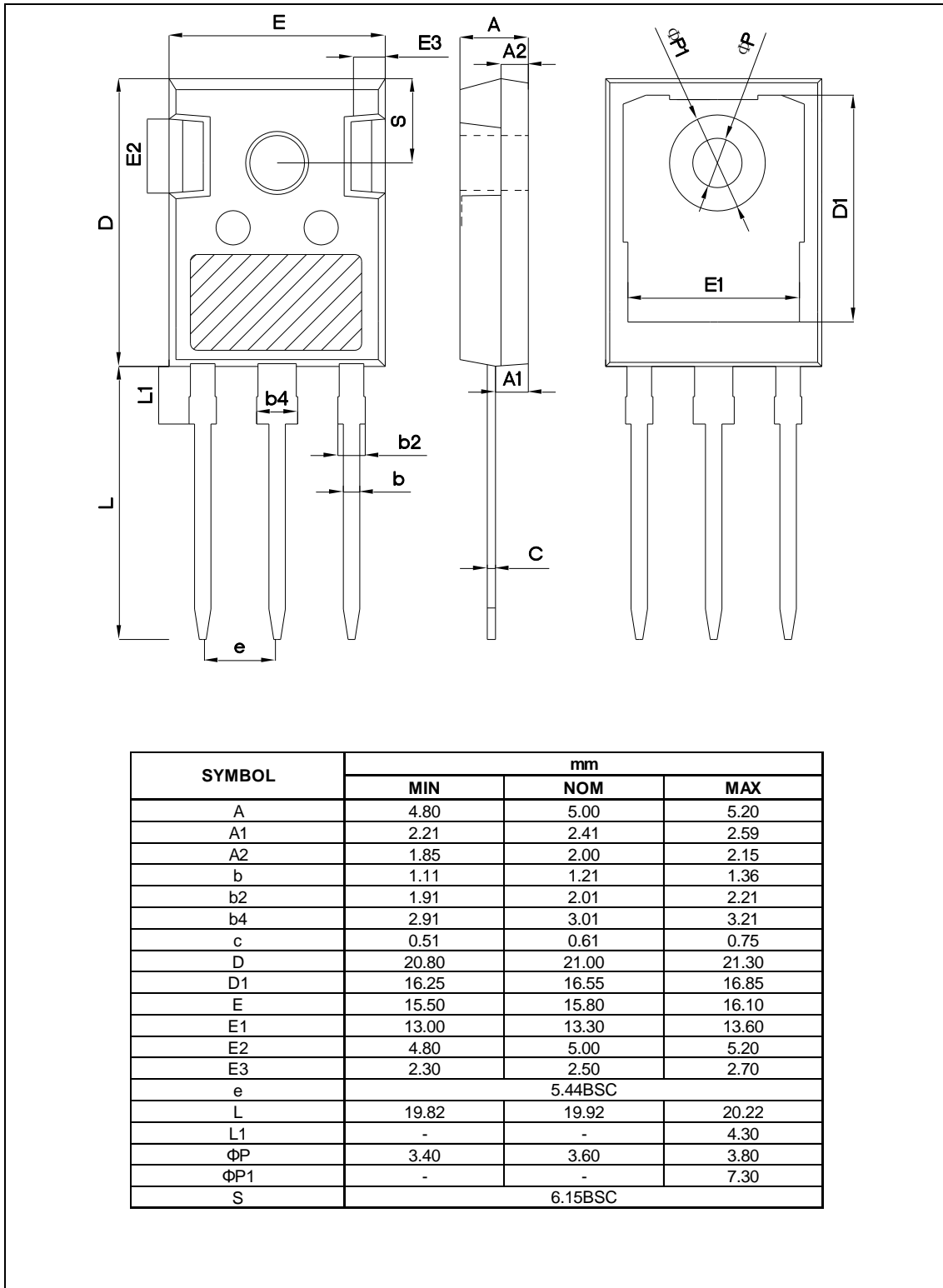

■ Ordering Information

Package	Units/Tube	Tubes/Inner Box	Units/Inner Box	Inner Box/Carton Box	Units/Carton Box
TO220F	50	20	1000	6	6000
TO263 ^{option1}	50	20	1000	6	6000
TO247	30	11	330	6	1980

Package	Units/Reel	Reels/Inner Box	Units/Inner Box	Inner Box/Carton Box	Units/Carton Box
TO263 ^{option2}	800	1	800	5	4000

■ Product Information

Product	Package	Pb Free	RoHS	Halogen Free
OSG65R140FSZF	TO220F	yes	yes	yes
OSG65R140KSZF	TO263	yes	yes	yes
OSG65R140HSZF	TO247	yes	yes	yes