

Enhancement Mode N-Channel Power MOSFET

Features

- ◆ Low $R_{DS(on)}$ & FOM
- ◆ Extremely low switching loss
- ◆ Excellent stability and uniformity
- ◆ Fast switching and soft recovery

Applications

- ◆ Consumer electronic power supply
- ◆ Motor control
- ◆ Synchronous rectification
- ◆ Isolated DC/DC convertor
- ◆ Invertors

■ General Description

SFS08R07GF uses advanced FSMOS™ technology to provide low $R_{DS(ON)}$, low gate charge, fast switching and excellent avalanche characteristics. This device is specially designed to get better ruggedness and suitable to use in synchronous rectification applications.

◆ $V_{DS, min}$	80 V
◆ $I_{D, pulse}$	192 A
◆ $R_{DS(ON), max @ V_{GS}=10 V}$	7 mΩ
◆ Q_g	28.9 nC

■ Schematic and Package Information

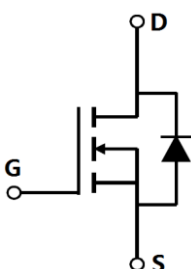
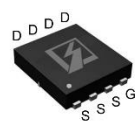
Schematic Diagram 	Pin Assignment Top View  PDFN5*6 SFS08R07GF
--	--

■ Absolute Maximum Ratings at $T_j=25^{\circ}C$ unless otherwise noted

Parameter	Symbol	Value	Unit
Drain source voltage	V_{DS}	80	V
Gate source voltage	V_{GS}	±20	V
Continuous drain current ¹⁾	I_D	64	A
Pulsed drain current ²⁾	$I_{D, pulse}$	192	A
Diode forward current	I_S	64	A
Pulsed source current	I_{SP}	192	A
Power dissipation ³⁾	P_D	87	W
Single pulsed avalanche energy ⁴⁾	E_{AS}	25	mJ
Operation and storage temperature	T_{stg}, T_j	-55 to 175	°C

■ Thermal Characteristics

Parameter	Symbol	Value	Unit
Thermal resistance, junction-case	$R_{\theta JC}$	1.72	$^{\circ}\text{C}/\text{W}$
Thermal resistance, junction-ambient ⁵⁾	$R_{\theta JA}$	62	$^{\circ}\text{C}/\text{W}$

■ Electrical Characteristics at $T_j=25^{\circ}\text{C}$ unless otherwise specified

Parameter	Symbol	Min.	Typ.	Max.	Unit	Test condition
Drain-source breakdown voltage	BV_{DSS}	80			V	$V_{GS}=0\text{ V}, I_D=250\ \mu\text{A}$
Gate threshold voltage	$V_{GS(th)}$	1.0		2.5	V	$V_{DS}=V_{GS}, I_D=250\ \mu\text{A}$
Drain-source on-state resistance	$R_{DS(on)}$		5.9	7	m Ω	$V_{GS}=10\text{ V}, I_D=12\text{ A}$
Drain-source on-state resistance	$R_{DS(on)}$		7.1	10	m Ω	$V_{GS}=4.5\text{ V}, I_D=9\text{ A}$
Gate-source leakage current	I_{GSS}			100	nA	$V_{GS}=20\text{ V}$
				-100		$V_{GS}=-20\text{ V}$
Drain-source leakage current	I_{DSS}			1	μA	$V_{DS}=80\text{ V}, V_{GS}=0\text{ V}$
Gate resistance	R_G		3.3		Ω	$f=1\text{ MHz}, \text{Open drain}$

■ Dynamic Characteristics

Parameter	Symbol	Min.	Typ.	Max.	Unit	Test condition
Input capacitance	C_{iss}		2028		pF	$V_{GS}=0\text{ V},$ $V_{DS}=25\text{ V},$ $f=100\text{ kHz}$
Output capacitance	C_{oss}		716.6		pF	
Reverse transfer capacitance	C_{rss}		53.9		pF	
Turn-on delay time	$t_{d(on)}$		22.2		ns	$V_{GS}=10\text{ V},$ $V_{DS}=50\text{ V},$ $R_G=2.5\ \Omega,$ $I_D=25\text{ A}$
Rise time	t_r		6.3		ns	
Turn-off delay time	$t_{d(off)}$		47.5		ns	
Fall time	t_f		8.8		ns	

■ Gate Charge Characteristics

Parameter	Symbol	Min.	Typ.	Max.	Unit	Test condition
Total gate charge	Q_g		28.9		nC	$I_D=25\text{ A}$, $V_{DS}=50\text{ V}$, $V_{GS}=10\text{ V}$
Gate-source charge	Q_{gs}		5.4		nC	
Gate-drain charge	Q_{gd}		4.9		nC	
Gate plateau voltage	V_{plateau}		3.5		V	

■ Body Diode Characteristics

Parameter	Symbol	Min.	Typ.	Max.	Unit	Test condition
Diode forward voltage	V_{SD}			1.3	V	$I_S=12\text{ A}$, $V_{GS}=0\text{ V}$
Reverse recovery time	t_{rr}		51.3		ns	$I_S=25\text{ A}$, $di/dt=100\text{ A}/\mu\text{s}$
Reverse recovery charge	Q_{rr}		60.6		nC	
Peak reverse recovery current	I_{rrm}		2		A	

■ Note

- 1) Calculated continuous current based on maximum allowable junction temperature.
- 2) Repetitive rating; pulse width limited by max. junction temperature.
- 3) P_d is based on max. junction temperature, using junction-case thermal resistance.
- 4) $V_{DD}=50\text{ V}$, $R_G=25\ \Omega$, $L=0.3\text{ mH}$, starting $T_j=25\text{ }^\circ\text{C}$.
- 5) The value of $R_{\theta JA}$ is measured with the device mounted on 1 in 2 FR-4 board with 2oz. Copper, in a still air environment with $T_a=25\text{ }^\circ\text{C}$.

■ **Electrical Characteristics Diagrams**

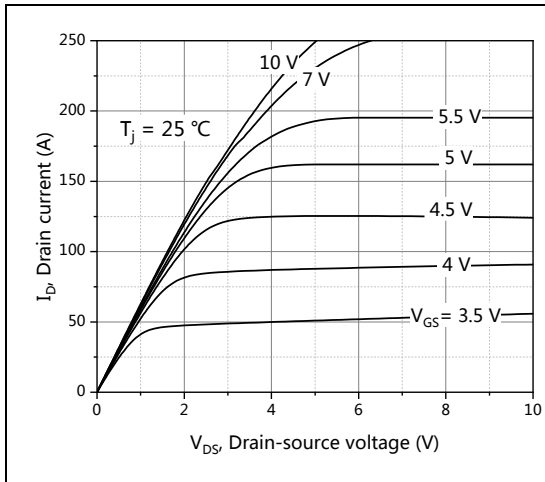

Figure 1, Typ. output characteristics

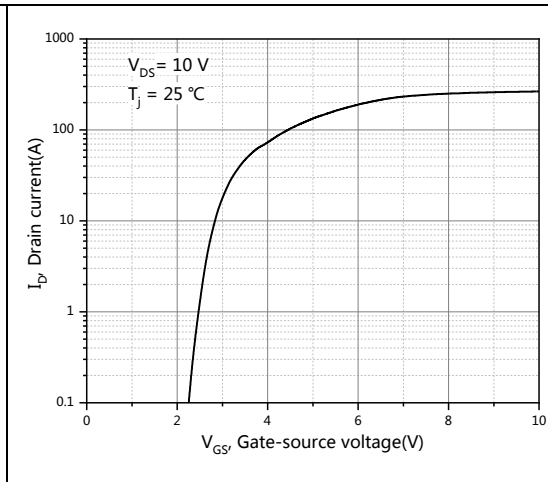

Figure 2, Typ. transfer characteristics

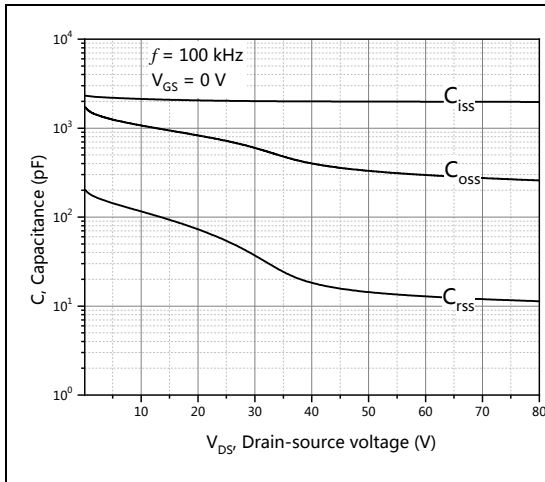

Figure 3, Typ. capacitances

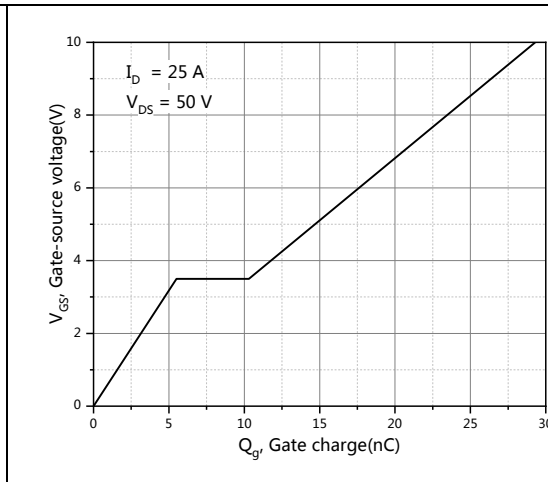

Figure 4, Typ. gate charge

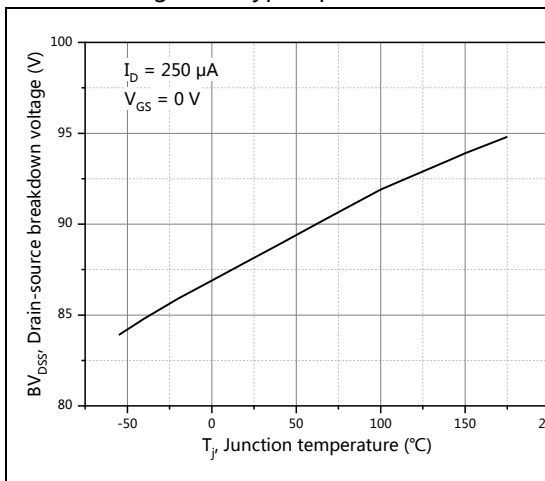

Figure 5, Drain-source breakdown voltage

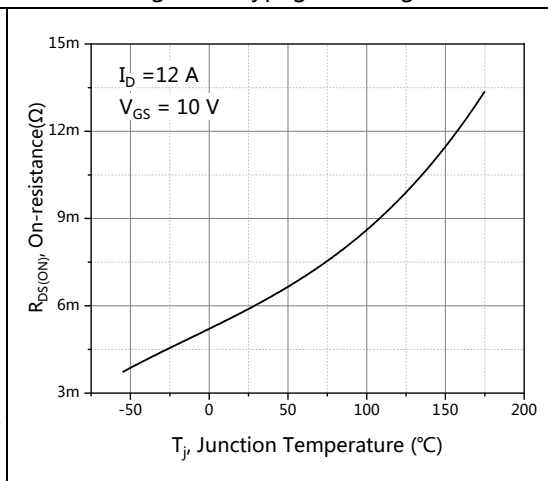

Figure 6, Drain-source on-state resistance

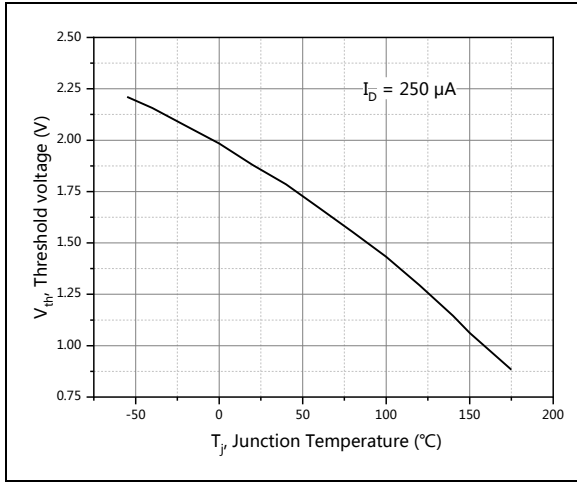

Figure 7, Threshold voltage

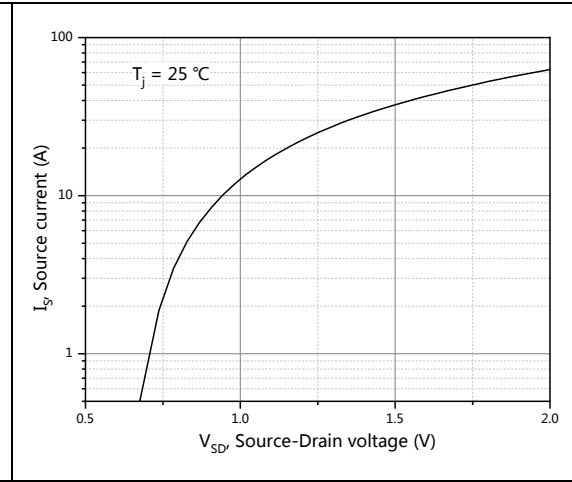

Figure 8, Forward characteristic of body diode

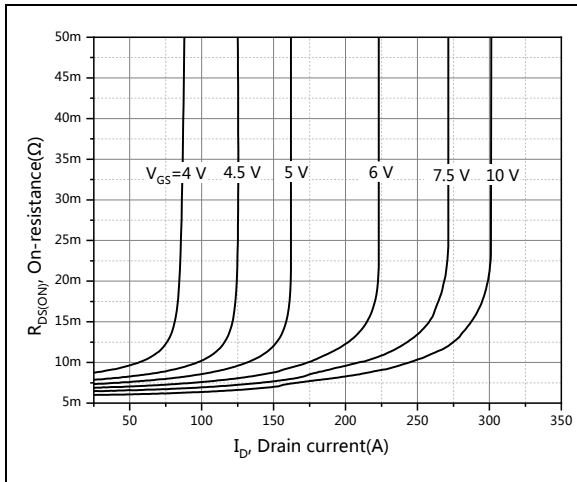

Figure 9, Drain-source on-state resistance

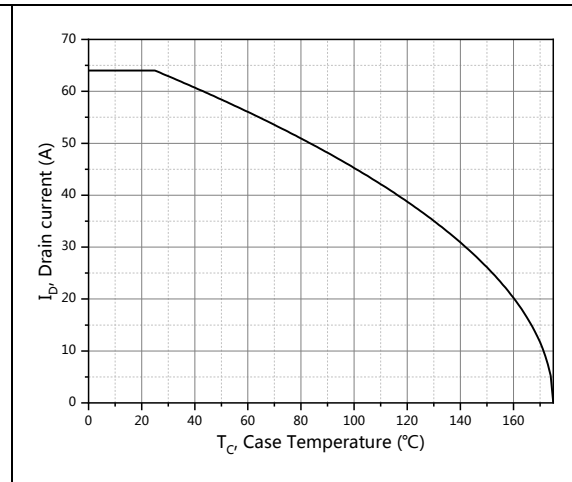

Figure 10, Drain current

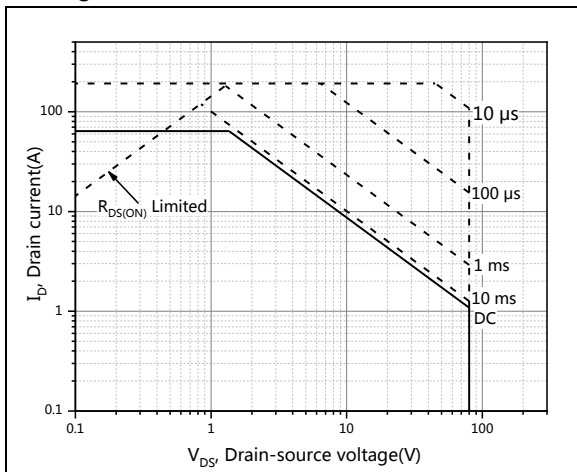

Figure 11, Safe operation area for $T_c = 25\text{ °C}$

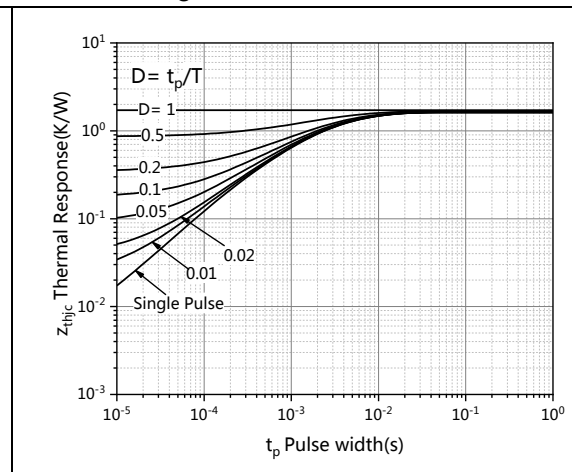

Figure 12, Max. transient thermal impedance

■ **Test circuits and waveforms**

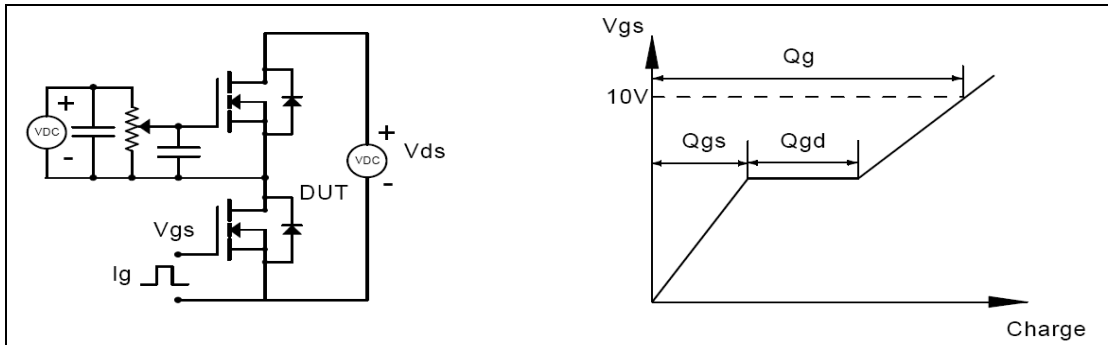

Figure 1, Gate charge test circuit & waveform

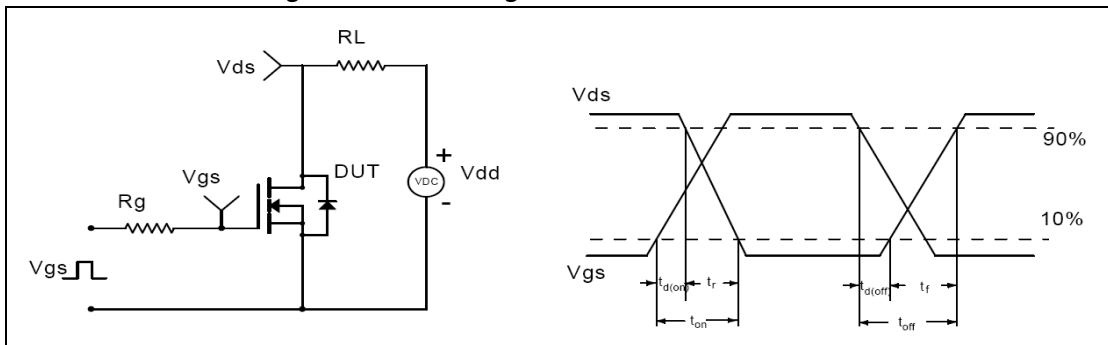

Figure 2, Switching time test circuit & waveforms

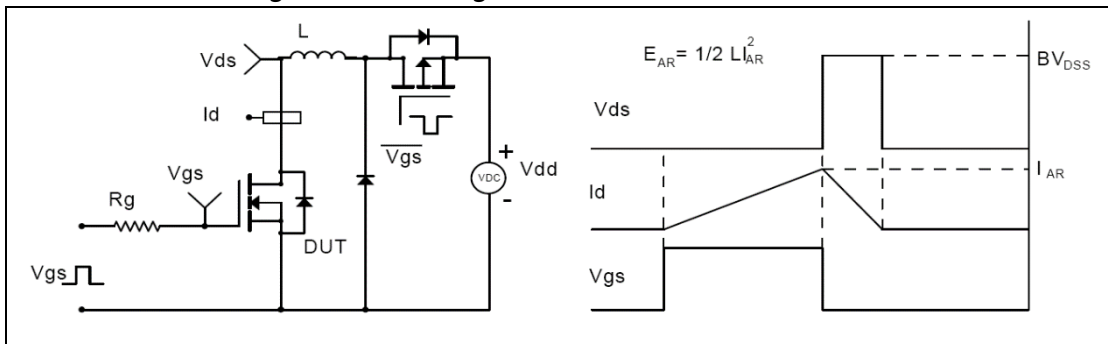

Figure 3, Unclamped inductive switching (UIS) test circuit & waveforms

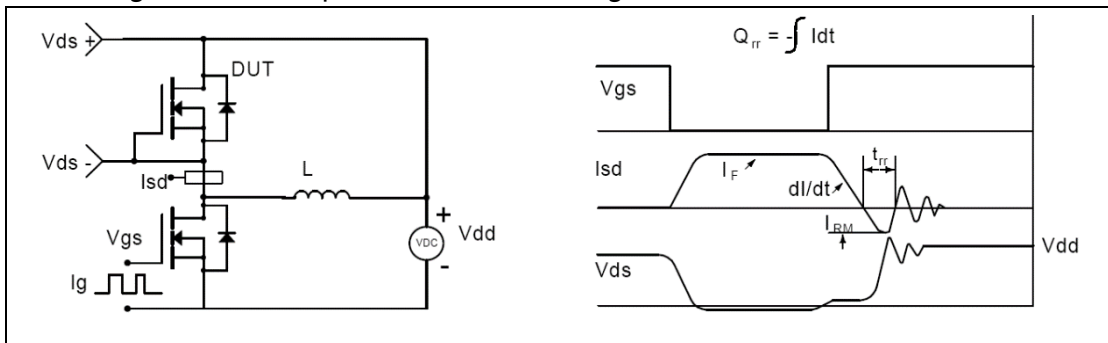
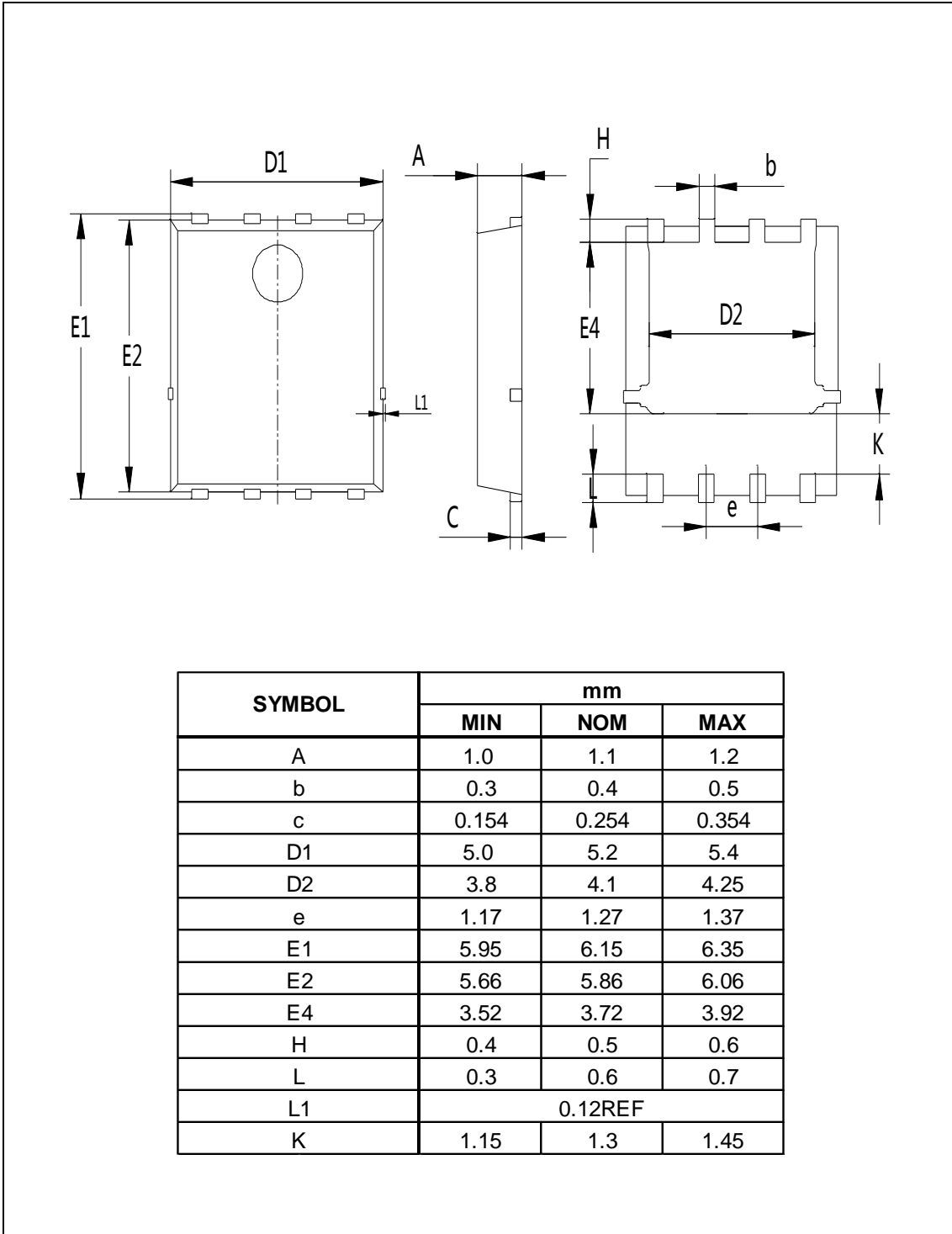

Figure 4, Diode reverse recovery test circuit & waveforms

■ **Package Information**

Figure1, PDFN5×6 package outline dimension



■ Package Information

Package	Units/Reel	Reels/Inner Box	Units/Inner Box	Inner Box/Carton Box	Units/Carton Box
PDFN5×6	5000	2	10000	5	50000

■ Product Information

Product	Package	Pb Free	RoHS	Halogen Free
SFS08R07GF	PDFN5×6	yes	yes	yes